

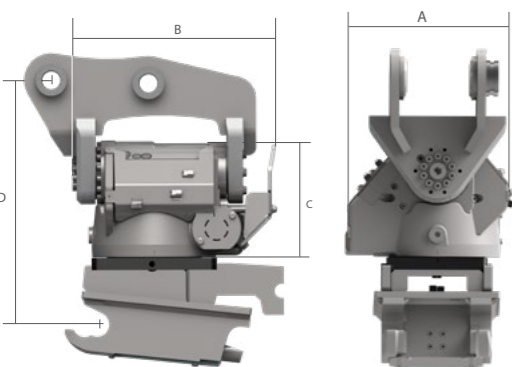

NB: AL HACER EL PEDIDO, ES NECESARIO NOTIFICAR EL VOLTAJE DEL SISTEMA ELÉCTRICO (12-24 V)

EL ACCIONADOR HIDRÁULICO GIRATORIO NOX TR PERMITE UNA ROTACIÓN DE 360° DE MANERA CONTINUA Y UN ÁNGULO DE INCLINACIÓN DE 50° A AMBOS LADOS, LO QUE GARANTIZA LA MÁXIMA EFICIENCIA EN CUALQUIER APLICACIÓN Y LO QUE SUPONE UN AHORRO DE TIEMPO Y RECURSOS. EN ESTE CASO, NO ES UN PROBLEMA LLENAR LAS ZANJAS DE MANERA DOSIFICADA Y PRECISA NI MANIPULAR VARIOS TIPOS DE MATERIALES EN ÁREAS RESTRINGIDAS. EL ACCIONADOR HIDRÁULICO GIRATORIO ESTÁ EQUIPADO CON ACOPLAMIENTO HIDRÁULICO ESTÁNDAR



TONS*	2,0 - 4,5	4,0 - 7,0	6,0 - 11,0	10,0 - 14,0	14,0 - 19,0	19,0 - 25,0
MOD.	ROTOTWIST NOX TR 045	ROTOTWIST NOX TR 07	ROTOTWIST NOX TR 11	ROTOTWIST NOX TR 14	ROTOTWIST NOX TR 19	ROTOTWIST NOX TR 25
A	MM 380	385	428	478	475	525
B	MM 435	460	550	730	760	845
C	MM 315	315	350	390	420	470
D (FROM)	MM 380	420	475	565	580	650
KG	SIN ENGANCHE, PLACA Y ENGANCHE RÁPIDO 150	200	320	485	580	860
L/MIN	ROTOTWIST 30 - 80	30 - 80	40 - 100	80 - 160	100 - 180	120 - 200
L/MIN	ACOPLAMIENTO HIDRÁULICO 70 / 30	70 / 30	70 / 30	70 / 30	70 / 30	70 / 30
KN	MAX. FUERZA DE ARRANQUE (ISO) 40	50	75	110	150	170
CONFIGURACIÓN	DF04	DF04	DF04	DF04	DF04	DF04
MM	ANCHURA MÁXIMA DEL CAZO 1100	1100	1300	1600	1700	2000

NB* LA CAPACIDAD DE ELEVACIÓN DEL GANCHO SE AJUSTA EN FUNCIÓN DEL SOPORTE AL QUE SE APLICA EL GANCHO.

* EL TONELAJE ES INDICATIVO; CANGINI SE RESERVA EL DERECHO DE CONTROLAR LOS GRUPOS SEGÚN LA CARGA OPERATIVA DE LA MÁQUINA DE TRABAJO.

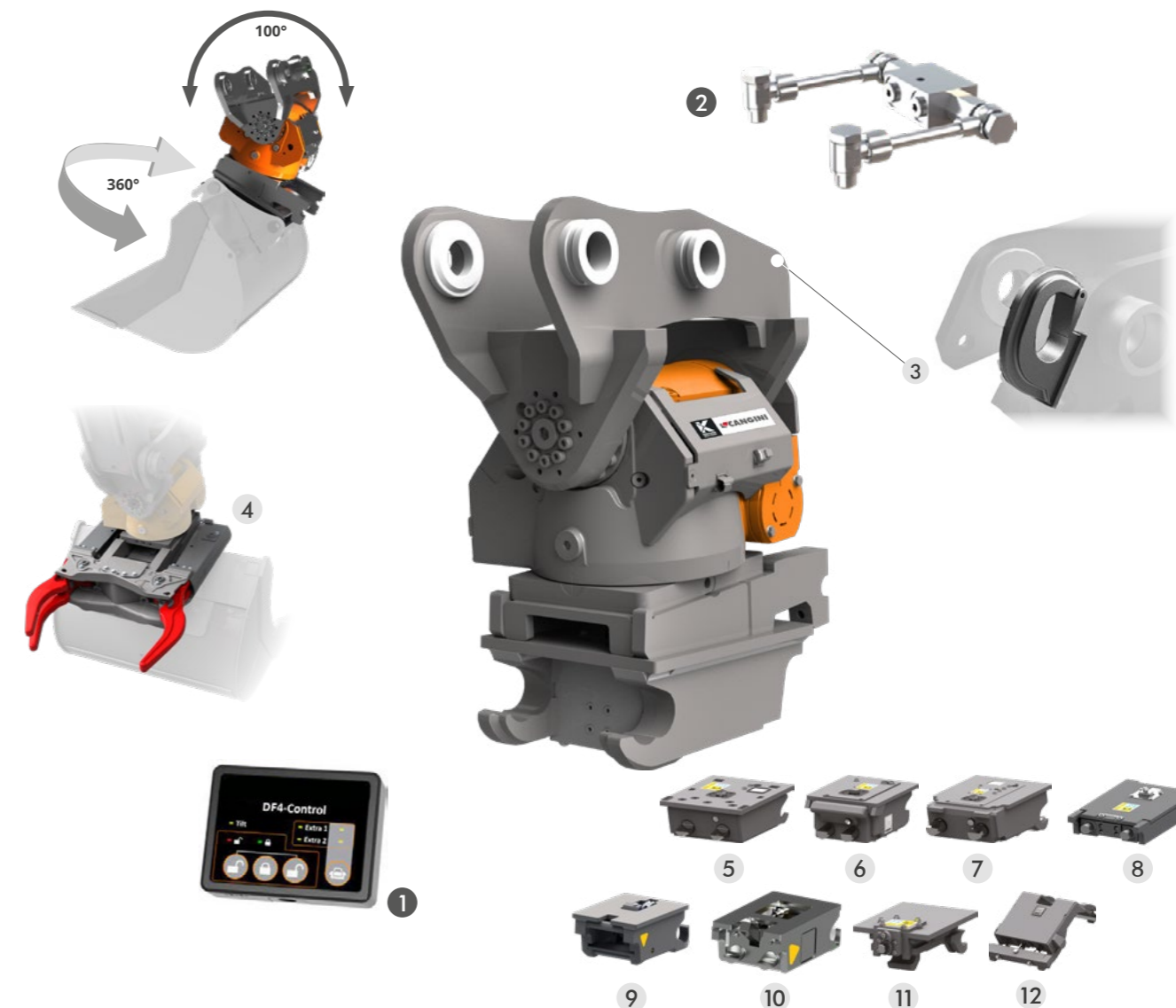

CARACTERÍSTICAS TÉCNICAS ESTÁNDAR

1 CONTROL BOX (DF04)

COMPONENTE ELECTRÓNICO QUE PERMITE CONTROLAR LAS DISTINTAS FUNCIONES DEL ROTOTWIST. DIRECTAMENTE DESDE LA CABINA, EL OPERADOR PUEDE CONTROLAR: LA ROTACIÓN, LA INCLINACIÓN, LAS LÍNEAS HIDRÁULICAS PARA LOS IMPLEMENTOS Y EL ENGANCHE RÁPIDO HIDRÁULICO CUANDO SEA NECESARIO. EL SISTEMA DF04 REQUIERE QUE LA MÁQUINA OPERADORA ESTÉ EQUIPADA CON DOS CONDUCTOS HIDRÁULICOS DE DOBLE EFECTO. SE PUEDEN CONSIDERAR OTRAS CONFIGURACIONES DE LA MÁQUINA OPERADORA DISTINTAS DE LA DF04.

2 VÁLVULA DE BLOQUEO

PERMITE MANTENER LA POSICIÓN ELEGIDA POR EL OPERADOR TAMBIÉN CUANDO LA MÁQUINA TIENE UNA INSTALACIÓN HIDRÁULICA DE CENTRO ABIERTO O EN CASO DE FUGA DEL DISTRIBUIDOR.

ACCESORIOS OPCIONALES

3 GANCHO DE ELEVACIÓN

TAMBIÉN ES POSIBLE TENER UN GANCHO HOMOLOGADO, SOLDADO DIRECTAMENTE EN EL ACCESORIO ROTOTWIST.

4 MÓDULO PINZA









IDEAL PARA MANIPULAR TRONCOS O TUBOS. ESTÁ INTEGRADA EN EL ENGANCHE RÁPIDO Y NO AFECTA A LA ALTURA NI AL MOVIMIENTO DEL ACCESORIO. EL MÓDULO DE PINZA SOLO ESTÁ DISPONIBLE EN ACOPLAMIENTOS DE DOBLE EFECTO

ENGANCHES RÁPIDOS ADAPTABLES

- 5 AR Fast Lock
- 6 CR Twin Lock • CR Twin Lock D.E.
- 7 CS Schnappmatic • CS Schnappmatic D.E.
- 8 CS Schnappmatic D.E. CS 100
- 9 CM Sicurmatic • M'Lock D.E.
- 10 S Nordic System • S Nordic EVO System
- 11 PL Pin Lock • PL Pin Lock D.E.
- 12 CW Hand'o'Lock • CW Hand'o'Lock D.E.

ENGANCHES RÁPIDOS ADAPTABLES



TONS		2,0 - 2,5	2,5 - 4,5	4,0 - 5,0	5,0 - 6,0	6,0 - 7,0	6,0 - 7,0	7,0 - 8,0	8,0 - 9,0	9,0 - 10,0	10,0 - 11,0	10,0 - 11,0	11,0 - 14,0	14,0 - 18,0	18,0 - 19,0	19,0 - 25,0	
		ROTOTWIST NOX TR 045			ROTOTWIST NOX TR 07			ROTOTWIST NOX TR 11					ROTOTWIST NOX TR 14		ROTOTWIST NOX TR 19		ROTOTWIST NOX TR 25
5	 AR FAST LOCK MECÁNICO SEMIAUTOMÁTICO	AR 30 S.A.	AR 40 S.A.	-	AR 50 S.A.	AR 50 S.A.	AR 70 S.A.	AR 70 S.A.	-	-	-	-	-	-	-	-	-
	AR FAST LOCK HIDRÁULICO SIMPLE EFECTO	AR 30 S.E.	AR 40 S.E.	-	AR 50 S.E.	AR 50 S.E.	AR 70 S.E.	AR 70 S.E.	-	-	-	-	-	-	-	-	-
6	 CR TWIN LOCK MECÁNICO SEMIAUTOMÁTICO	CR 30 S.A.	CR 40 S.A.	-	CR 50 S.A.	CR 50 S.A.	CR 70 S.A.	CR 70 S.A.	CR 70 S.A.	CR 70 S.A.	CR 70 S.A.	CR 70 S.A.	CR 70 S.A.	-	-	-	
	CR TWIN LOCK HIDRÁULICO SIMPLE EFECTO	CR 30 S.E.	CR 40 S.E.	-	CR 50 S.E.	CR 50 S.E.	CR 70 S.E.	CR 70 S.E.	CR 70 S.E.	CR 70 S.E.	CR 70 S.E.	CR 70 S.E.	CR 70 S.E.	-	-	-	
	CR TWIN LOCK HIDRÁULICO DOBLE EFECTO	CR 30 D.E.	CR 40 D.E.	-	CR 50 D.E.	CR 50 D.E.	CR 70 D.E.	CR 70 D.E.	CR 70 D.E.	CR 70 D.E.	CR 70 D.E.	CR 70 D.E.	CR 70 D.E.	-	-	-	
7	 CS SCHNAPPATIC MECÁNICO SEMIAUTOMÁTICO	CS 10 S.A.	CS 30 S.A.	-	CS 30 S.A.	CS 80 S.A.	CS 80 S.A.	CS 80 S.A.	CS 80 S.A.	CS 80 S.A.	CS 80 S.A.	CS 80 S.A.	CS 80 S.A.	-	-	-	
	CS SCHNAPPATIC HIDRÁULICO SIMPLE EFECTO	CS 10 S.E.	CS 30 S.E.	-	CS 30 S.E.	CS 80 S.E.	CS 80 S.E.	CS 80 S.E.	CS 80 S.E.	CS 80 S.E.	CS 80 S.E.	CS 80 S.E.	CS 80 S.E.	-	-	-	
	CS SCHNAPPATIC HIDRÁULICO DOBLE EFECTO	CS 10 D.E.	CS 30 D.E.	-	CS 30 D.E.	CS 80 D.E.	CS 80 D.E.	CS 80 D.E.	CS 80 D.E.	CS 80 D.E.	CS 80 D.E.	CS 80 D.E.	CS 80 D.E.	-	-	-	
8	 CS 100 SCHNAPPATIC HIDRÁULICO DOBLE EFECTO	-	-	-	-	-	-	-	-	-	-	-	CS 100 D.E.	CS 100 D.E.	CS 100 D.E.	-	
9	 CM SICURMATIC MECÁNICO SEMIAUTOMÁTICO	M'LOCK 30 S.A.	M'LOCK 30 S.A.	-	M'LOCK100	M'LOCK100	M'LOCK100	M'LOCK100	M'LOCK100	M'LOCK100	M'LOCK100	M'LOCK100	-	-	-	-	
	M'LOCK HIDRÁULICO DOBLE EFECTO	M'LOCK 30 D.E.	M'LOCK 30 D.E.	-	M'LOCK 100 D.E.	M'LOCK 100 D.E.	M'LOCK 100 D.E.	M'LOCK 100 D.E.	M'LOCK 100 D.E.	M'LOCK 180 D.E.	M'LOCK 180 D.E.	M'LOCK 180 D.E.	M'LOCK 180 D.E.	M'LOCK 180 D.E.	-	-	
10	 S NORDIC SYSTEM MECÁNICO SEMIAUTOMÁTICO	S 30 S.A.	S 40-200 S.A.	-	S 40-200 S.A.	S 40-200 S.A.	-	-	-	-	-	-	-	-	-	-	
	S NORDIC SYSTEM HIDRÁULICO DOBLE EFECTO	S 30 D.E.	S 40-200 D.E.	-	S 40-200 D.E.	S 40-200 D.E.	S 45 D.E.	S 45 D.E.	S 45 D.E.	S 45 D.E.	S 45 D.E.	S 45 D.E.	S 45 D.E.	S 45 D.E.	S 45 D.E.	S 60 D.E.	-
							S 50 D.E.	S 50 D.E.	S 50 D.E.	S 50 D.E.	S 50 D.E.	S 50 D.E.	S 50 D.E.	S 50 D.E.	S 50 D.E.	S 60 D.E.	-
11	 PL PIN LOCK MECÁNICO	PL 20 S.A.	PL 40 S.A.	PL 60	PL 60	PL 60	PL 60	PL 80	PL 80	PL 80	-	-	-	-	-	-	
	PL PIN LOCK HIDRÁULICO DOBLE EFECTO	-	PL 40 D.E.	PL 60 D.E.	PL 60 D.E.	PL 60 D.E.	PL 60 D.E.	PL 80 D.E.	PL 80 D.E.	PL 80 D.E.	-	-	PL 100 D.E.	PL 100 D.E.	-	-	
12	 CW HAND'O'LOCK / AUTO'LOCK MECÁNICO	CW 05 S.A.	CW 05	-	CW 10	CW 10	CW 10	CW 10	CW 10	CW 10	-	-	-	-	-	-	
	CW HAND'O'LOCK HIDRÁULICO DOBLE EFECTO	CW 05 D.E.	-	-	CW 10 D.E.	CW 10 D.E.	CW 10 D.E.	CW 10 D.E.	CW 10 D.E.	CW 20S D.E.	CW 20S D.E.	CW 20S D.E.	CW 20S D.E.	CW 30S D.E.	CW 30S D.E.	CW 30S D.E.	

MÓDULO PINZA



		TONS			6,0 - 7,0					10,0 - 11,0		14,0 - 18,0		18,0 - 19,0		19,0 - 25,0				
		4,0 - 5,0			5,0 - 6,0			6,0 - 7,0			10,0 - 11,0		11,0 - 14,0		14,0 - 18,0		18,0 - 19,0	19,0 - 25,0		
		ROTOTWIST NOX TR 07			ROTOTWIST NOX TR 11					ROTOTWIST NOX TR 14		ROTOTWIST NOX TR 19		ROTOTWIST NOX TR 25						
4	 CR TWIN LOCK HIDRÁULICO DOBLE EFECTO	MOD.	TRG 11	TRG 11	TRG 11	TRG 11	TRG 11	TRG 11	TRG 11	TRG 11	TRG 11	TRG 11	TRG 11	TRG 11	TRG 11	TRG 11	TRG 11			
			CR 50 D.E.	CR 50 D.E.	CR 50 D.E.	CR 50 D.E.	CR 50 D.E.	CR 50 D.E.	CR 50 D.E.	CR 50 D.E.	CR 50 D.E.	CR 50 D.E.	CR 50 D.E.	CR 50 D.E.	CR 50 D.E.	CR 50 D.E.	CR 50 D.E.	CR 50 D.E.		
4	 CS SCHNAPPMATIC HIDRÁULICO DOBLE EFECTO	MOD.	TRG 07	TRG 11	TRG 11	TRG 11	TRG 11	TRG 11	TRG 11	TRG 11	TRG 11	TRG 11	TRG 11	TRG 11	TRG 11	TRG 11	TRG 11	TRG 11		
			CS 30 D.E.	CS 80 D.E.	CS 80 D.E.	CS 80 D.E.	CS 80 D.E.	CS 80 D.E.	CS 80 D.E.	CS 80 D.E.	CS 80 D.E.	CS 80 D.E.	CS 80 D.E.	CS 80 D.E.	CS 80 D.E.	CS 80 D.E.	CS 80 D.E.	CS 80 D.E.	CS 80 D.E.	
4	 CS 100 SCHNAPPMATIC HIDRÁULICO DOBLE EFECTO	MOD.	-	-	-	-	-	-	-	-	-	TRG 19	TRG 19	TRG 19	TRG 19	TRG 19	TRG 19	TRG 19		
			-	-	-	-	-	-	-	-	-	CS 100 D.E.	CS 100 D.E.	CS 100 D.E.	CS 100 D.E.	CS 100 D.E.	CS 100 D.E.	CS 100 D.E.	CS 100 D.E.	
4	 M'LOCK HIDRÁULICO DOBLE EFECTO	MOD.	TRG 11	TRG 11	TRG 11	TRG 11	TRG 11	TRG 11	TRG 11	TRG 11	TRG 11	TRG 19	TRG 19	TRG 19	TRG 19	TRG 19	TRG 19	TRG 19	TRG 19	
			M'LOCK 100 D.E.	M'LOCK 100 D.E.	M'LOCK 100 D.E.	M'LOCK 100 D.E.	M'LOCK 100 D.E.	M'LOCK 100 D.E.	M'LOCK 100 D.E.	M'LOCK 100 D.E.	M'LOCK 100 D.E.	M'LOCK 180 D.E.	M'LOCK 180 D.E.	M'LOCK 180 D.E.	M'LOCK 180 D.E.	M'LOCK 180 D.E.	M'LOCK 180 D.E.	M'LOCK 180 D.E.	M'LOCK 180 D.E.	
4	 S NORDIC SYSTEM HIDRÁULICO DOBLE EFECTO	MOD.	TRG 07	TRG 07	TRG 11	TRG 11	TRG 11	TRG 11	TRG 11	TRG 11	TRG 11	TRG 11	TRG 11	TRG 11	TRG 11	TRG 11	TRG 11	TRG 11	TRG 11	
			S 40-200 D.E.	S 40-200 D.E.	S 45 D.E.	S 45 D.E.	S 45 D.E.	S 45 D.E.	S 45 D.E.	S 45 D.E.	S 45 D.E.	S 45 D.E.	S 45 D.E.	S 45 D.E.	S 45 D.E.	S 45 D.E.	S 45 D.E.	S 45 D.E.	S 45 D.E.	
					S 50 D.E.	S 50 D.E.	S 50 D.E.	S 50 D.E.	S 50 D.E.	S 50 D.E.	S 50 D.E.	S 50 D.E.	S 50 D.E.	S 50 D.E.	S 50 D.E.	S 50 D.E.	S 50 D.E.	S 50 D.E.	S 50 D.E.	
4	 PL PIN LOCK HIDRÁULICO DOBLE EFECTO	MOD.	TRG 11	TRG 11	TRG 11	TRG 11	TRG 11	TRG 11	TRG 11	TRG 11	TRG 11	TRG 11	TRG 11	TRG 11	TRG 11	TRG 11	TRG 11	TRG 11	TRG 11	
			PL 60 D.E.	PL 60 D.E.	PL 60 D.E.	PL 60 D.E.	PL 60 D.E.	PL 60 D.E.	PL 60 D.E.	PL 60 D.E.	PL 60 D.E.	PL 60 D.E.	PL 60 D.E.	PL 60 D.E.	PL 60 D.E.	PL 60 D.E.	PL 60 D.E.	PL 60 D.E.	PL 60 D.E.	PL 60 D.E.
4	 CW HAND'O'LOCK HIDRÁULICO DOBLE EFECTO	MOD.	TRG 11	TRG 11	TRG 11	TRG 11	TRG 11	TRG 11	TRG 11	TRG 11	TRG 11	TRG 19	TRG 19	TRG 19	TRG 19	TRG 19	TRG 19	TRG 19	TRG 19	
			CW 10 D.E.	CW 10 D.E.	CW 10 D.E.	CW 10 D.E.	CW 10 D.E.	CW 10 D.E.	CW 10 D.E.	CW 10 D.E.	CW 10 D.E.	CW 20S D.E.	CW 20S D.E.	CW 20S D.E.	CW 20S D.E.	CW 20S D.E.	CW 20S D.E.	CW 20S D.E.	CW 20S D.E.	CW 20S D.E.